

A2

SmartLock

smartLock



Simplicity! - reduce the need for sandbags

SmartLock can be used to replace or reduce the number of sandbags used to secure your 'A' frames.

**Safe
Simple
Easy**



- To fit, loop the clip around the barrier and frame as shown in the diagrams. Pull the loose end to take up the slack in the strap.
- The strap should not be loose when fitted, but must not be over-tightened.
- When fitted, the **buckle should not be in contact with the barrier or 'A' Frame.**
- When properly fitted and in good condition, SmartLock will hold up to 300kg or the equivalent to 24 sandbags.

For safe operation you should use SmartLock strap where you would use 10 sandbags and use at least two straps per frame.

Recommended methods of using SmartLock to secure an 'A' Frame:

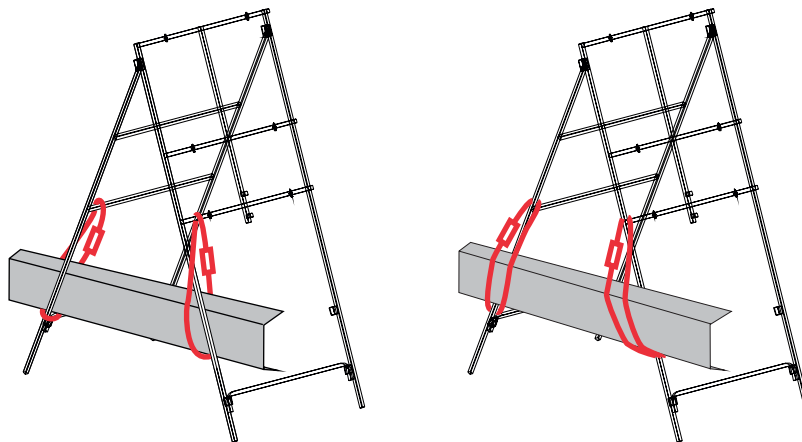

Remember, SmartLock is only as good as the barrier it is attached to. SmartLock should not be used if visibly damaged or worn. Contact Morelock Signs Ltd if you have any comments or questions.



For more details please call our sales dept:

Tel: 01902 637575 Fax: 01902 637576

email: sales@morelock.co.uk www.morelock.co.uk